





ITEM NAME /NOM D' ITEM:MICAELA ARM CHAIR

ITEM # /NO. ITEM:101258 (IVORY&GOLD)

101259 (GRAY&GOLD)

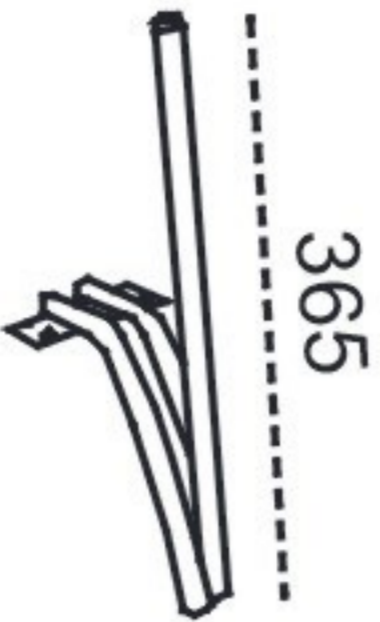
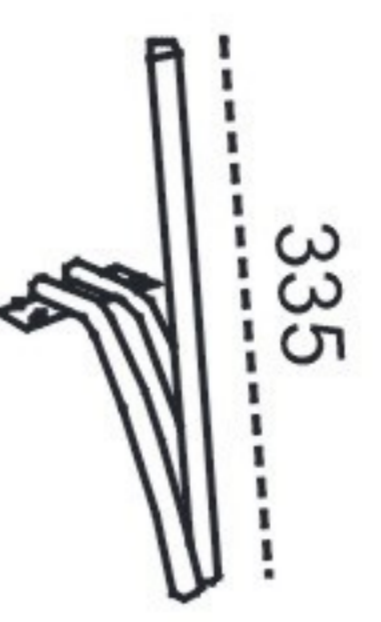
Enquiry:parts@zuomod.com

PART LIST/Liste des pièces

(1)	(2)	(3)	(4)
 X1	 Front Legs X2	 Rear Legs X2	1.  X16 M6*25 2.  X16 3.  X16 4.  X1

INSTRUCTION

A

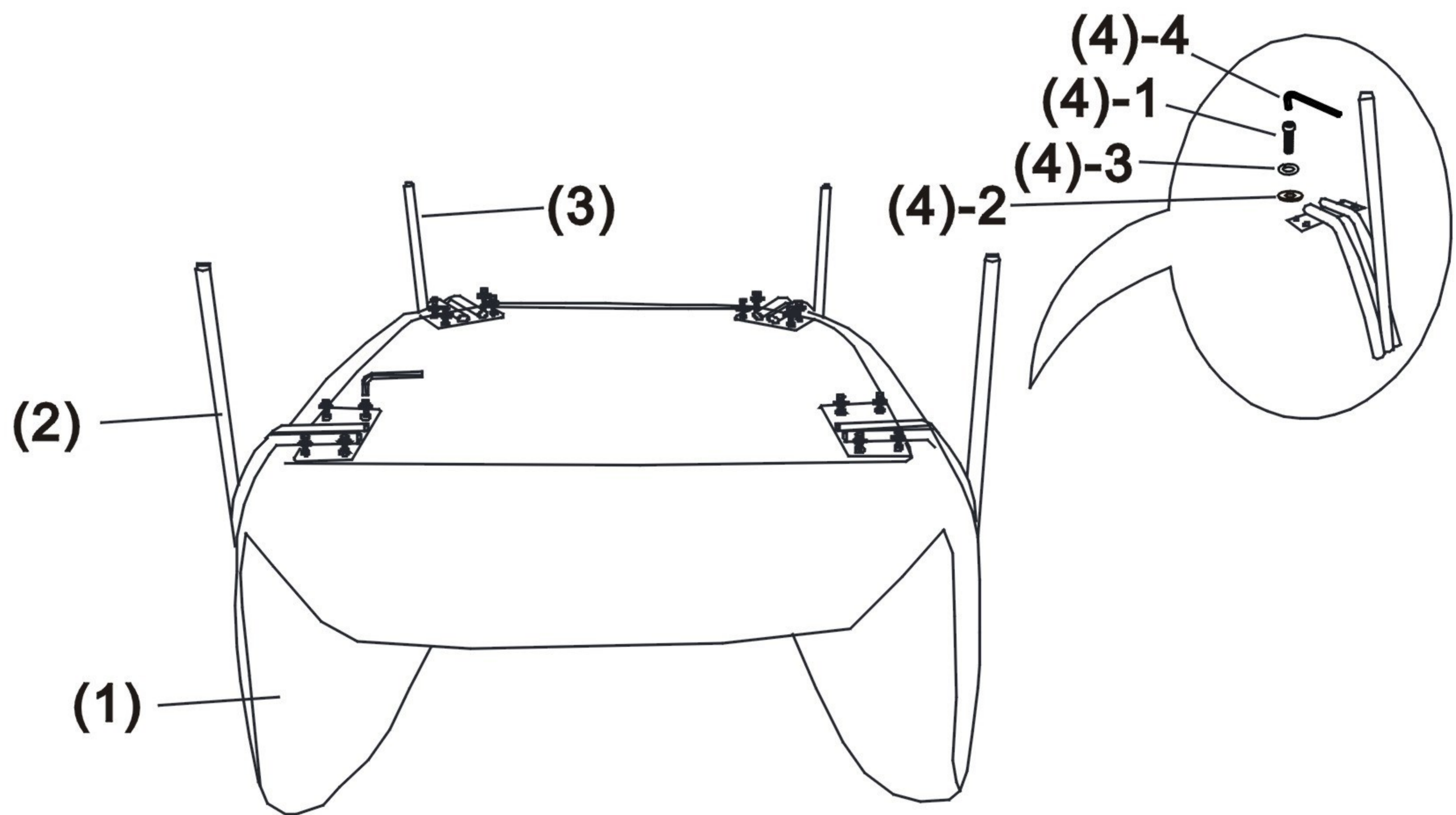

B

