

# OTUS

## Warranty Disclaimer

This Limited Warranty applies to physical goods, and only for physical goods, purchased from Matrix Imports Inc ("MIX").

### What does this limited warranty cover?

This Limited Warranty covers any defects in material or workmanship under normal use during the Warranty Period.

During the Warranty Period, MIX will repair or replace, at no charge, products or parts of a product that proves to be defective due to improper material or workmanship, under normal use and maintenance.

### What will we do to correct problems?

MIX will either repair the Product at no charge, using new or refurbished replacement parts within the United States upon availability.

How long does the coverage last?

The Warranty Period for Physical Goods purchased from MIX is 1-year from the date of purchase.

A replacement Physical Good or part assumes the remaining warranty of the original Physical Good or 90 days from the date of replacement or repair, whichever is longer.

### What does this limited warranty not cover?

Our products are not under warranty for damage to upholstery, printed table tops, wood or metal finishes nor damages which result from neglect, accident, intentional misuse or acts of nature such as lightning, floods, earthquakes, normal wear and tear, exposure to extremes in temperature or humidity, immersion in water, fading or variations in color or finish over time, scratches, blemishes or slight color variations in wood grain, minor variations in size, unauthorized repair, damages caused to assembly with power tools for assembly, alteration, abuse or misuse of Product, lack of routine proper maintenance, use of abrasive or improper cleaners, damages occurred in transit by a delivery carrier used by customer, other persons, pets, or rodents.

### What do you have to do?

To obtain warranty service, you must first contact us by e-mail at [customercare@mixhomefurniture.com](mailto:customercare@mixhomefurniture.com) to determine the problem and the most appropriate solution for you. Please include a Proof of Purchase from the Retailer/Dealer where you acquired your product.

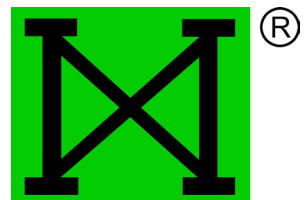
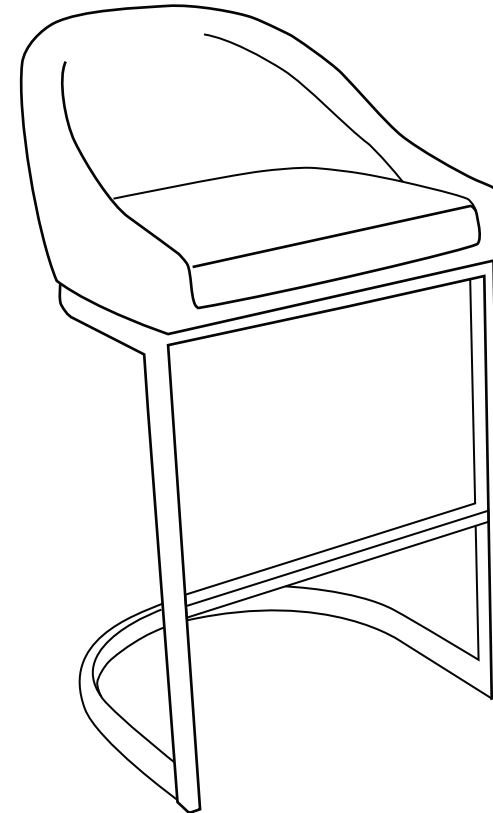





## **Product Care**

Avoid placing your furniture in direct sunlight and maintain at least two feet between furniture and heat sources. PU/Leatherette are especially sensitive to direct sunlight. To clean the PU/Leatherette Cover, wipe clean with a soft cloth moistened with a Leather Cleaner and Conditioner. Do not use bleach, multi-purpose cleaners, chemicals, water or biological products. To clean the metal parts, use a Stainless-Steel cleaner on the regular basis especially in areas of high humidity otherwise rusting or squeaking may occur. Do not use power tools to assemble this product.

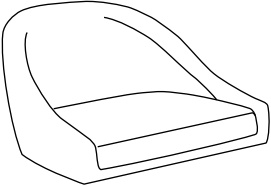
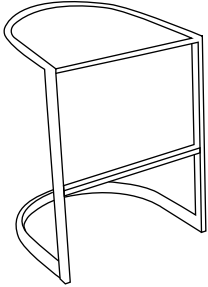
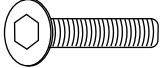
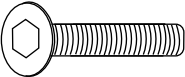
# Parts List

Part #	Part Image	Part Description	Qty
1		Seat	1
2		Frame	1
3		M6 X 1 inch	2
4		M6 X 1 1/4 inch	2
5		Allen Wrench	1

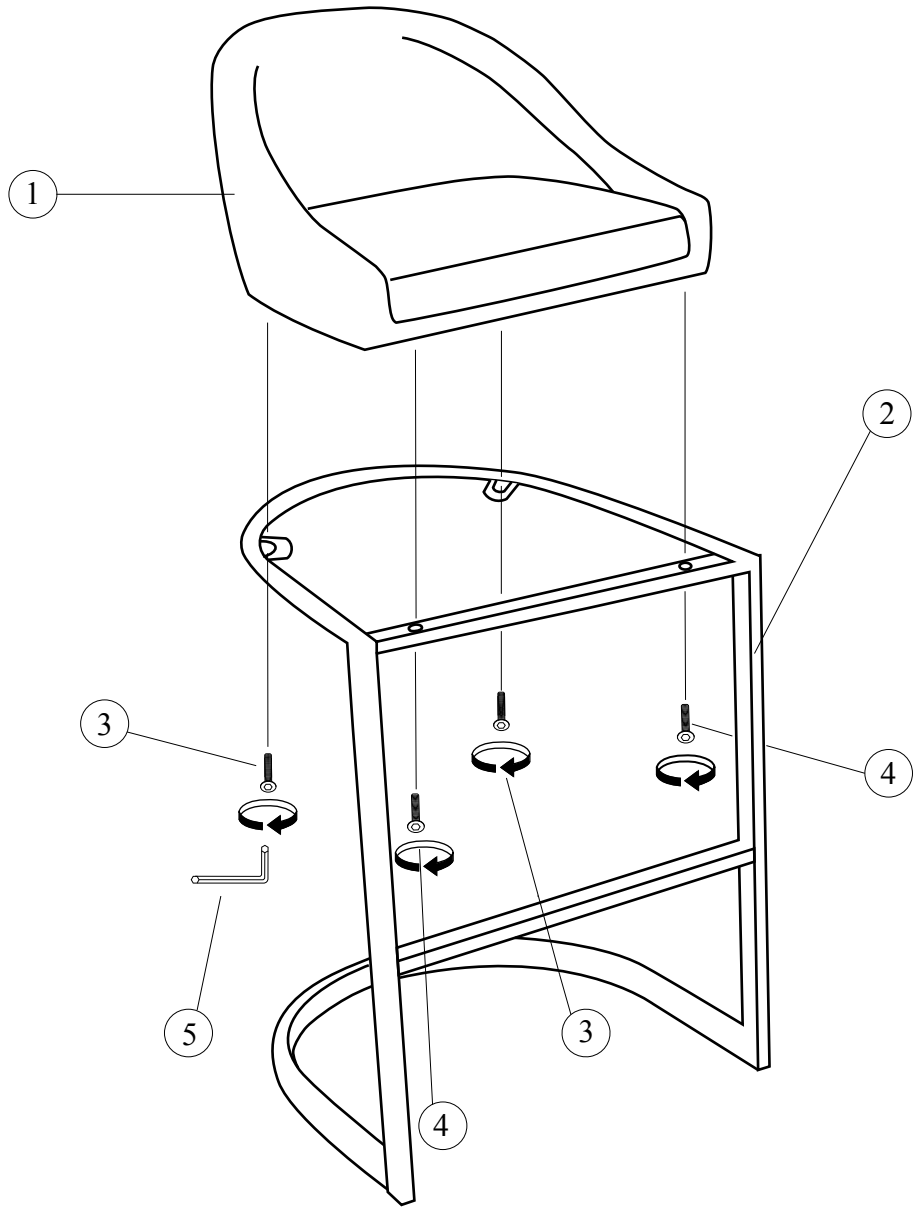

3

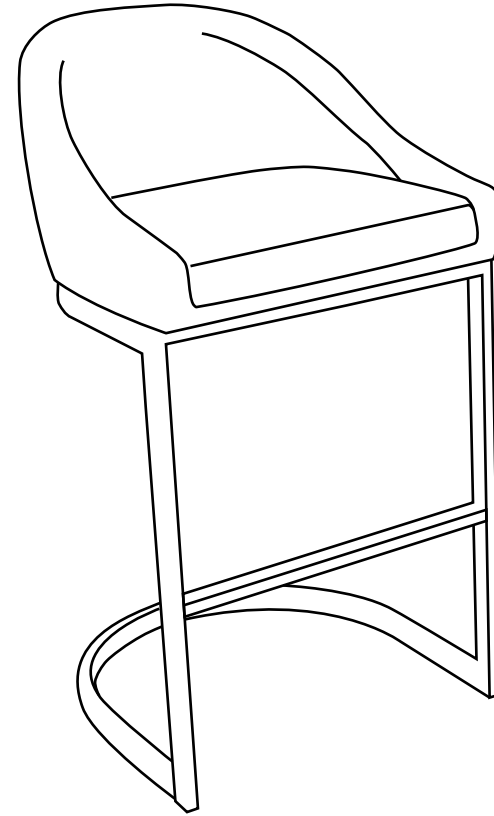

4