

60" S

Item Number:
E645-V60S-MCA
E645-V60S-GW

JAMES MARTIN



VANITIES™

Addison 60" Single Cabinet
Diagrams with Dimensions
page 01 of 03

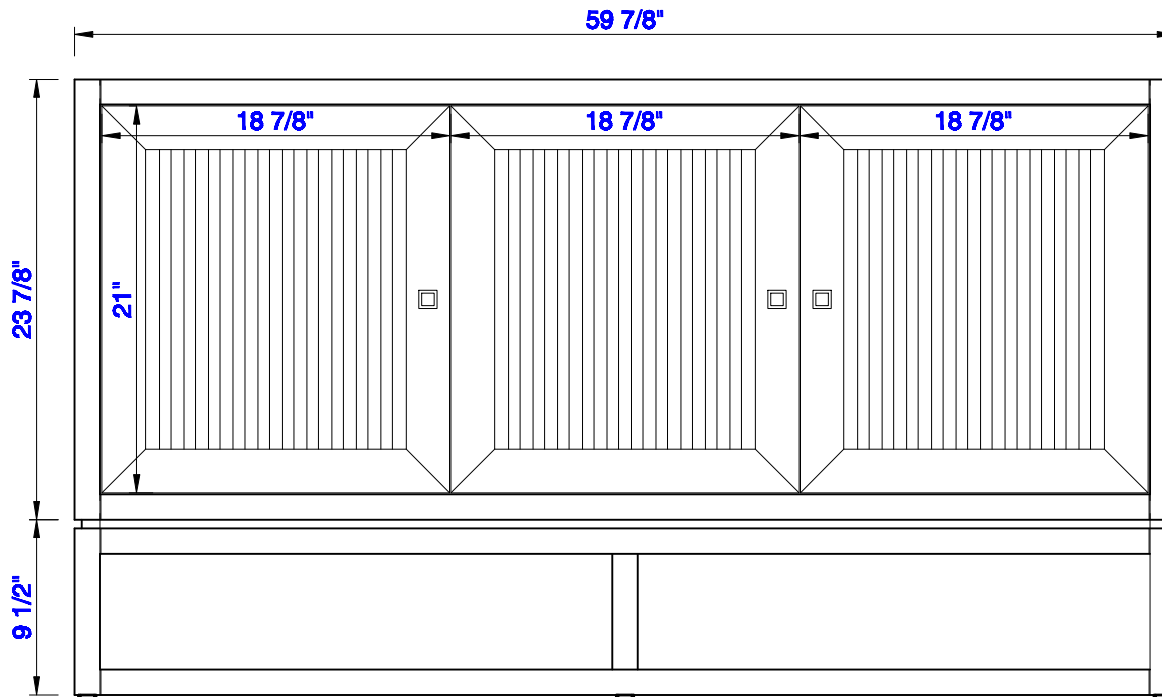

NOTE ONE: Countertops are not shown in these diagrams. (Cabinet Only)

NOTE TWO: This vanity does not have a Backsplash.

Please consult our website for Countertop Diagrams: www.jamesmartinvanities.com

Version:202010

60" S

Item Number:
E645-V60S-MCA
E645-V60S-GW

JAMES MARTIN



VANITIES™

Addison 60" Single Cabinet
Diagrams with Dimensions
page 02 of 03

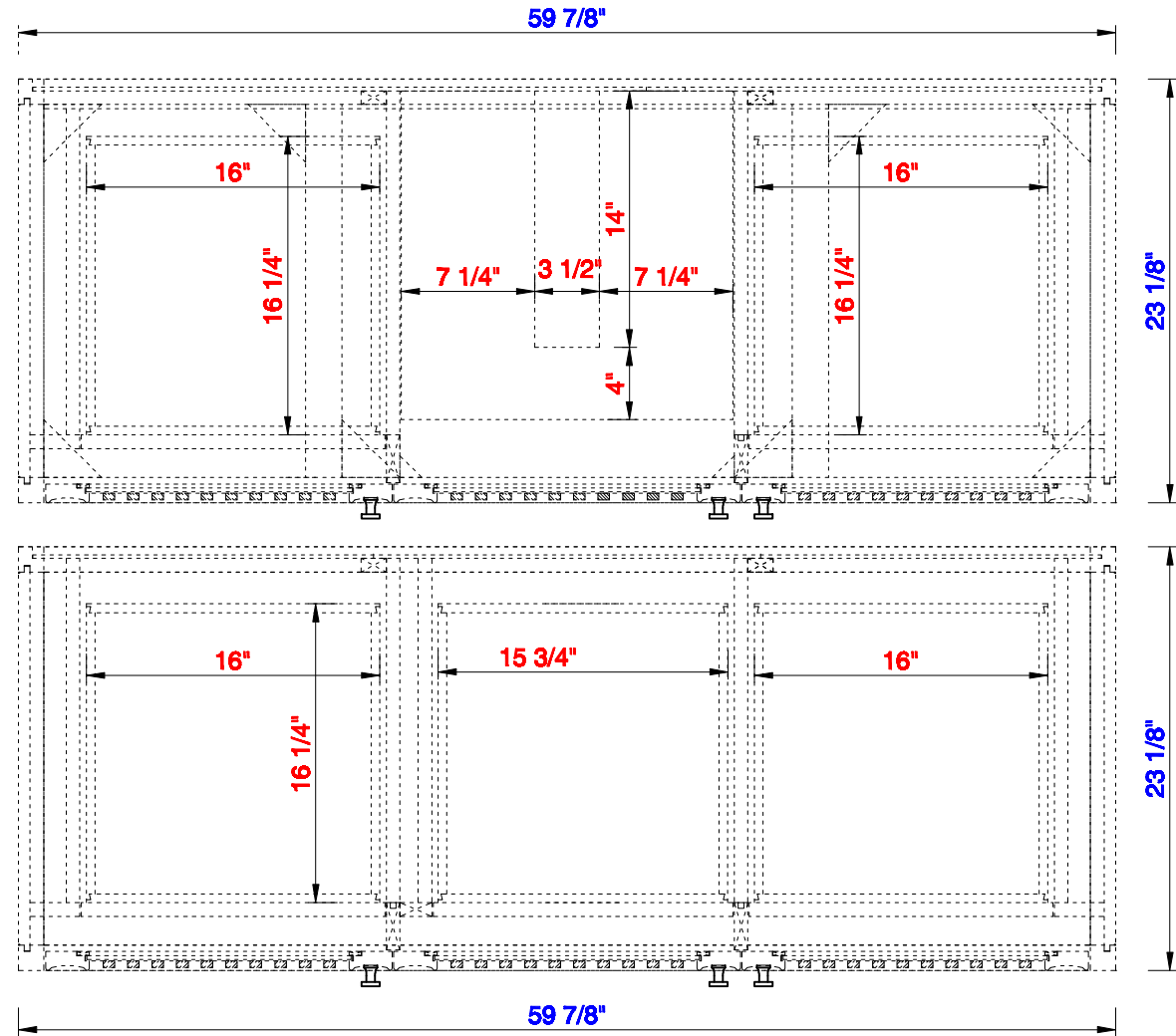

NOTE ONE: Countertops are not shown in these diagrams . (Cabinet Only)
NOTE TWO: Internal Shelves (Shown) are designed to align with sinks in James Martin's Optional Countertops.
Customer's own countertops and sinks may align differently, and modification may be required.
Please consult our website for Countertop Diagrams: www.jamesmartinvanities.com

Version:202010

60" S

Item Number:
E645-V60S-MCA
E645-V60S-GW

JAMES MARTIN

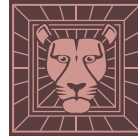

VANITIES™

Addison 60" Single Cabinet
Diagrams with Dimensions
page 03 of 03

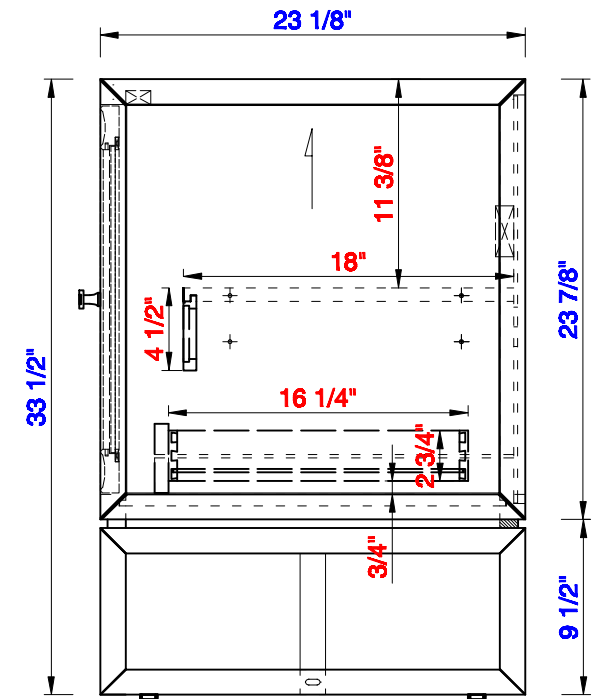
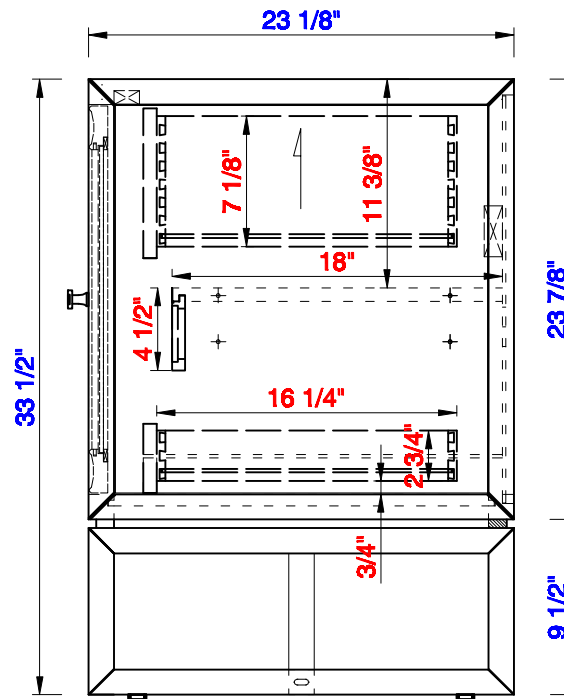
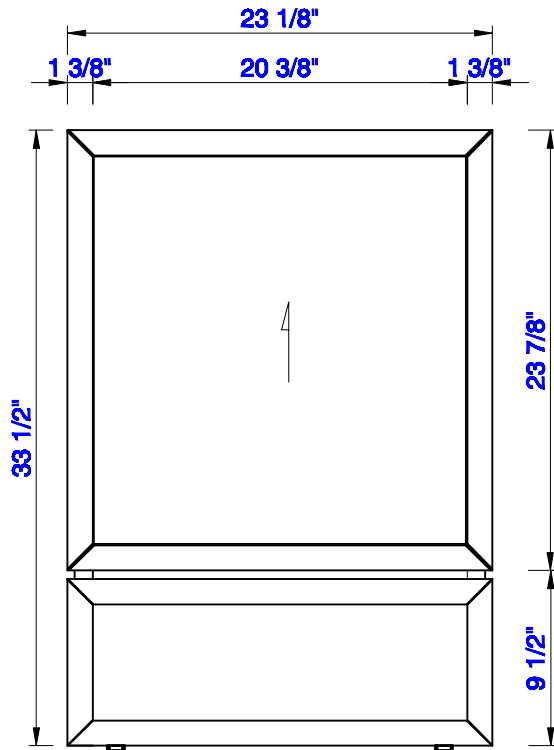

NOTE ONE: Countertops are not shown in these diagrams . (Cabinet Only)

NOTE TWO: This vanity does not have a Backsplash.

Please consult our website for Countertop Diagrams: www.jamesmartinvanities.com

Version:202010

1524mm

Item Number:
E645-V60S-MCA
E645-V60S-GW

JAMES MARTIN

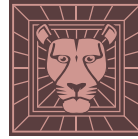

VANITIES™

Addison 1524mm Single Cabinet
Diagrams with Dimensions
page 01 of 03

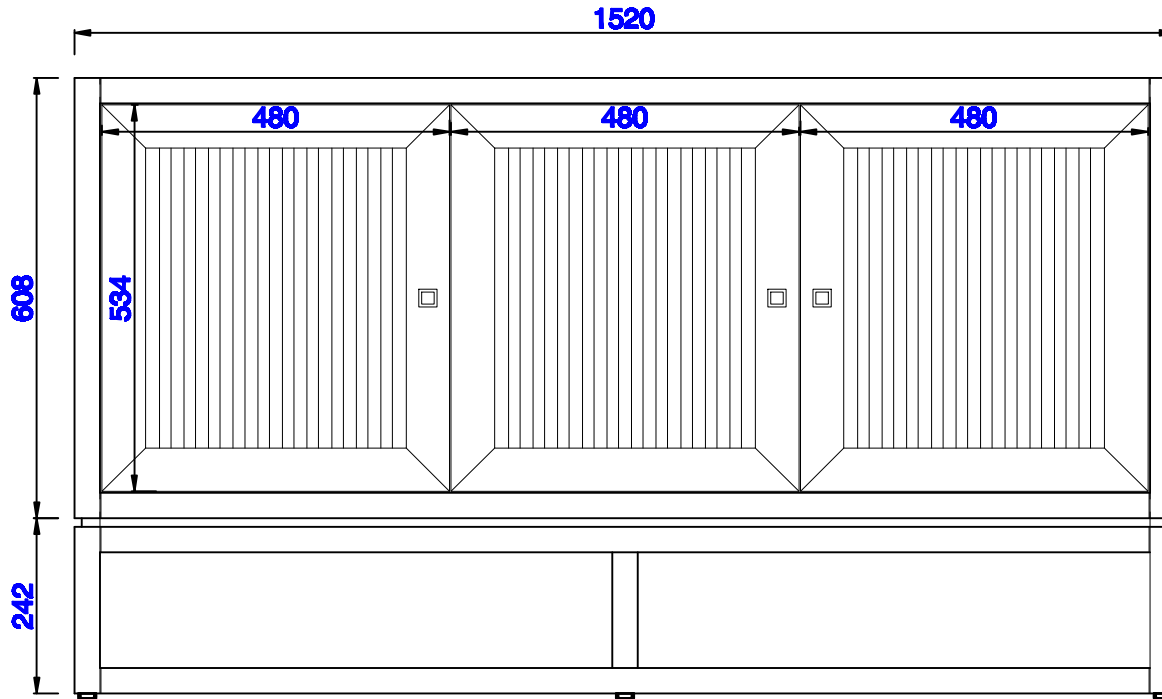

NOTE ONE: Countertops are not shown in these diagrams. (Cabinet Only)

NOTE TWO: This vanity does not have a Backsplash.

Please consult our website for Countertop Diagrams: www.jamesmartinvanities.com

Version:202010

1524mm

Item Number:
E645-V60S-MCA
E645-V60S-GW

JAMES MARTIN

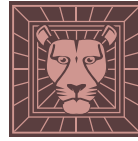

VANITIES™

Addison 1524mm Single Cabinet
Diagrams with Dimensions
page 02 of 03

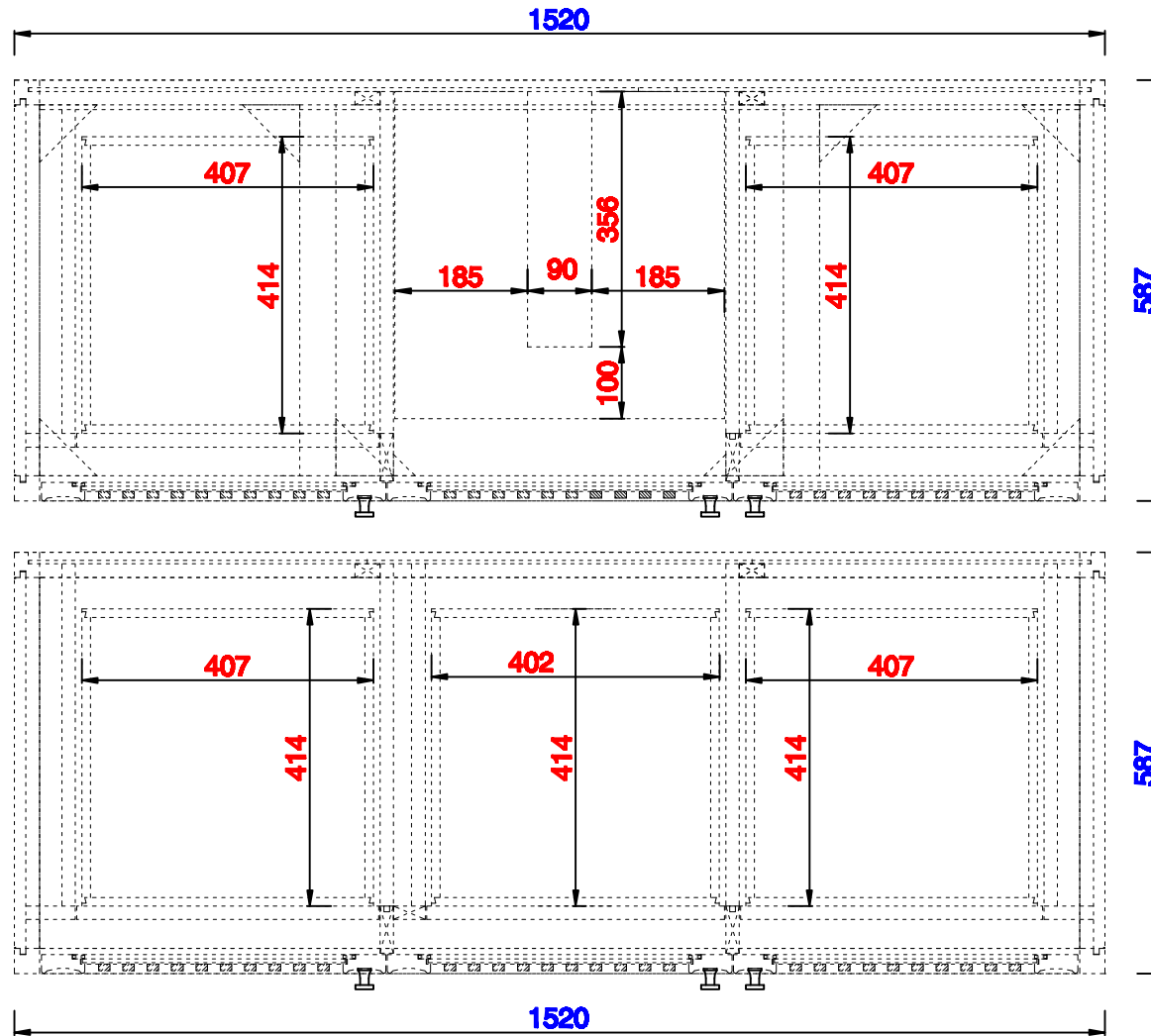

NOTE ONE: Countertops are not shown in these diagrams . (Cabinet Only)

NOTE TWO: Internal Shelves (Shown) are designed to align with sinks in James Martin's Optional Countertops. Customer's own countertops and sinks may align differently, and modification may be required. Please consult our website for Countertop Diagrams: www.jamesmartinvanities.com

Version:202010

1524mm

Item Number:
E645-V60S-MCA
E645-V60S-GW

JAMES MARTIN

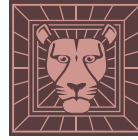

VANITIES™

Addison 1524mm Single Cabinet
Diagrams with Dimensions
page 03 of 03

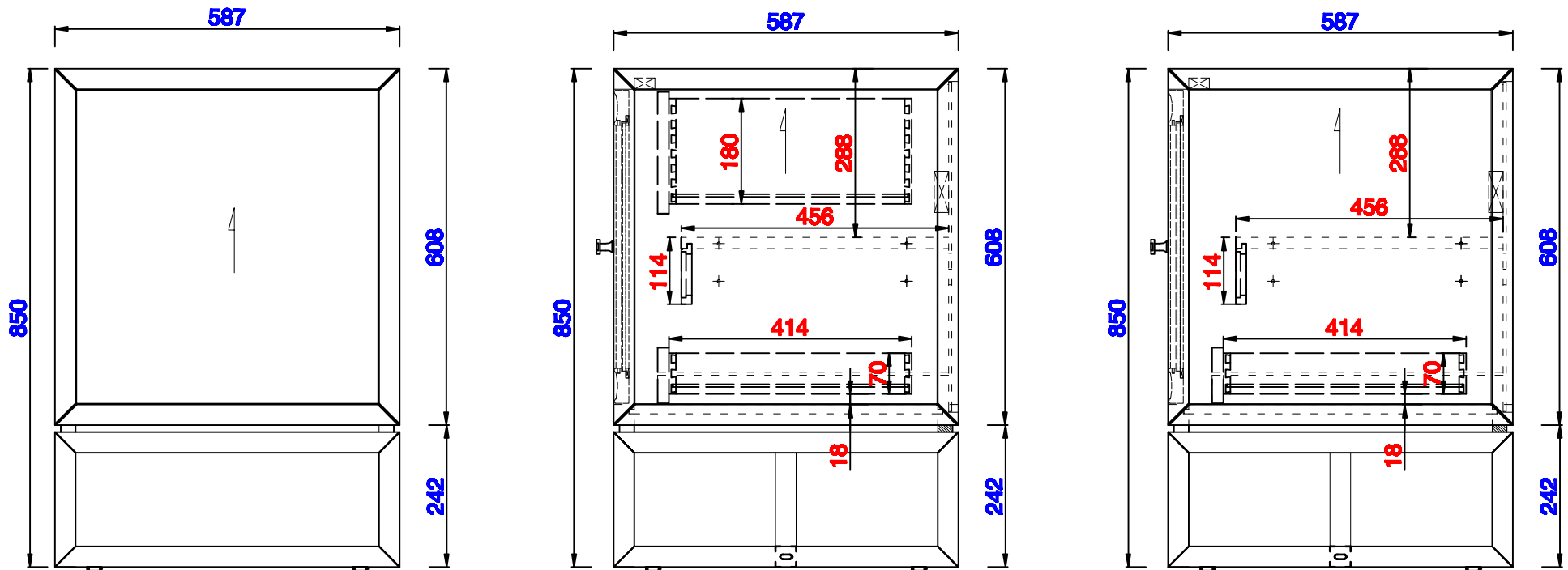

NOTE ONE: Countertops are not shown in these diagrams . (Cabinet Only)

NOTE TWO: This vanity does not have a Backsplash.

Please consult our website for Countertop Diagrams: www.jamesmartinvanities.com

Version:202010