

26"

Item Number:
147-114-V26-AQB
147-114-V26-BNM
147-114-V26-COK
147-114-V26-WCH
147-114-V26-BW

JAMES MARTIN

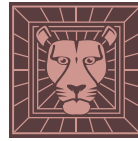

VANITIES™

Brookfield 26" Single Vanity Cabinet

Diagrams with Dimensions

page 01 of 03

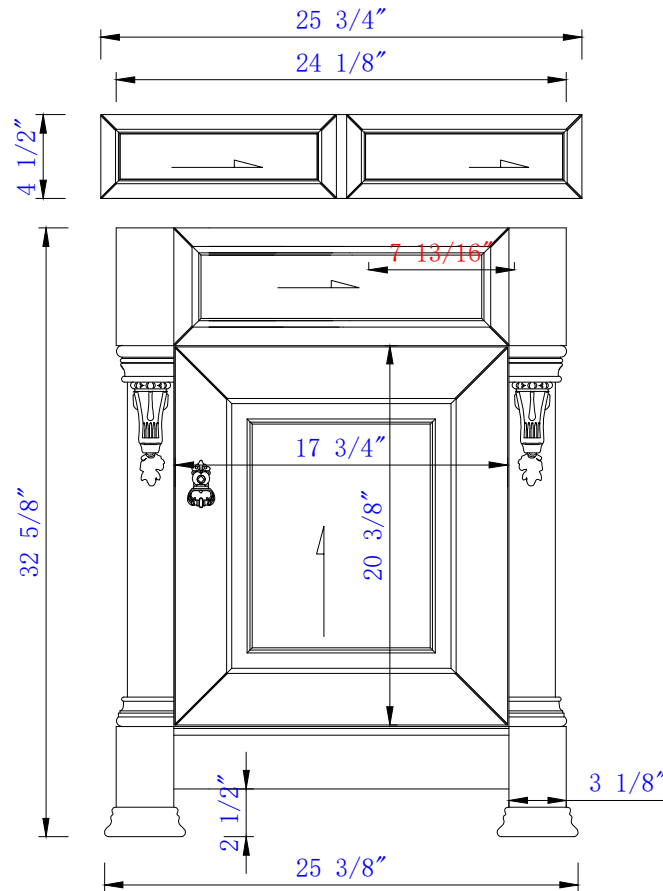

NOTE ONE: Countertops are not shown in these diagrams .(Cabinet Only)

NOTE TWO: Wood Backsplash (Shown) is designed for the molding detail to align with sinks in James Martin's Optional Countertops.

Customers' own countertops and sinks may align differently.

Please consult our website for Countertop Diagrams: www.jamesmartinvanities.com

Version:202107

26"

Item Number:
147-114-V26-AQB
147-114-V26-BNM
147-114-V26-COK
147-114-V26-WCH
147-114-V26-BW

JAMES MARTIN

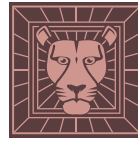

VANITIES™

Brookfield 26" Single Vanity Cabinet
Diagrams with Dimensions
page 02 of 03

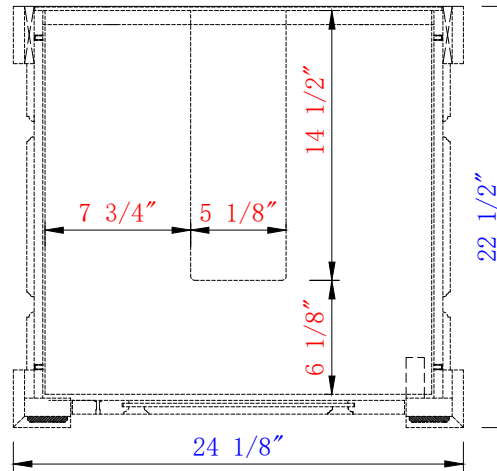
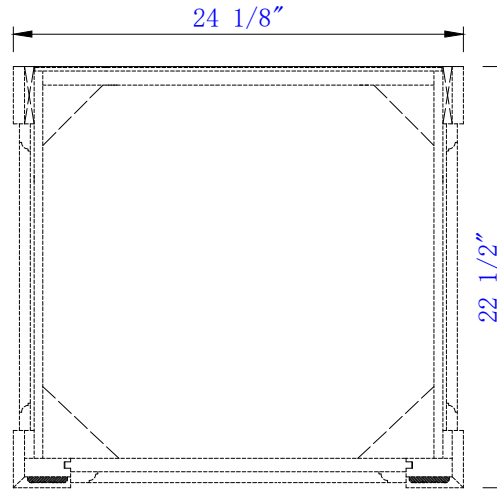

NOTE ONE: Countertops are not shown in these diagrams .(Cabinet Only)

NOTE TWO: Internal Shelves (Shown) are designed to align with sinks in James Martin's Optional Countertops.

Customers' own countertops and sinks may align differently, and modification may be required.

Please consult our website for Countertop Diagrams: www.jamesmartinvanities.com

Version:202107

26"

Item Number:
147-114-V26-AQB
147-114-V26-BNM
147-114-V26-COK
147-114-V26-WCH
147-114-V26-BW

JAMES MARTIN

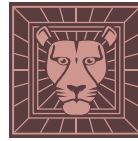

VANITIES™

Brookfield 26" Single Vanity Cabinet

Diagrams with Dimensions

page 03 of 03

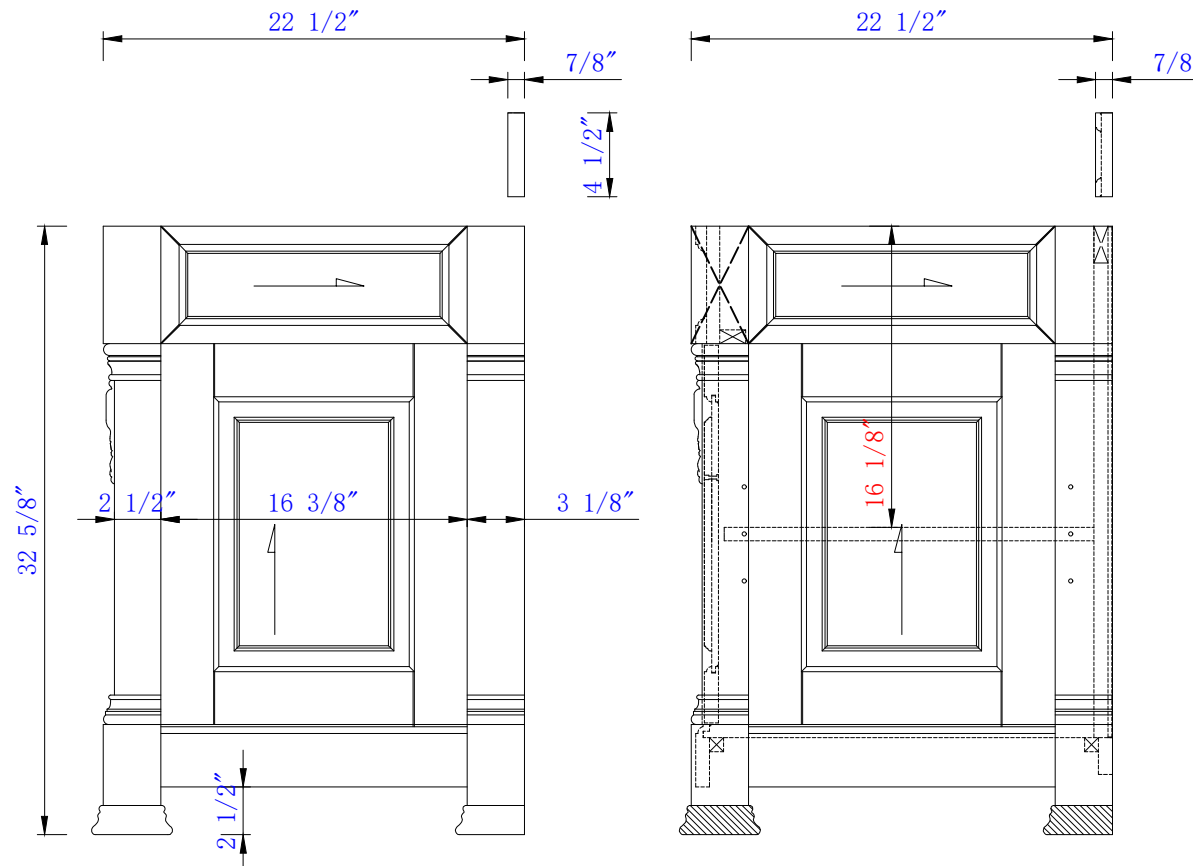

NOTE ONE: Countertops are not shown in these diagrams .(Cabinet Only)

NOTE TWO: Wood Backsplash (Shown) is designed for the molding detail to align with sinks in James Martin's Optional Countertops.

Customers' own countertops and sinks may align differently.

Please consult our website for Countertop Diagrams: www.jamesmartinvanities.com

Version:202107

660mm

Item Number:
147-114-V26-AQB
147-114-V26-BNM
147-114-V26-COK
147-114-V26-WCH
147-114-V26-BW

JAMES MARTIN

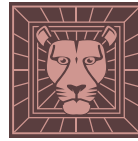

VANITIES™

Brookfield 660mm Single Vanity Cabinet

Diagrams with Dimensions

page 01 of 03

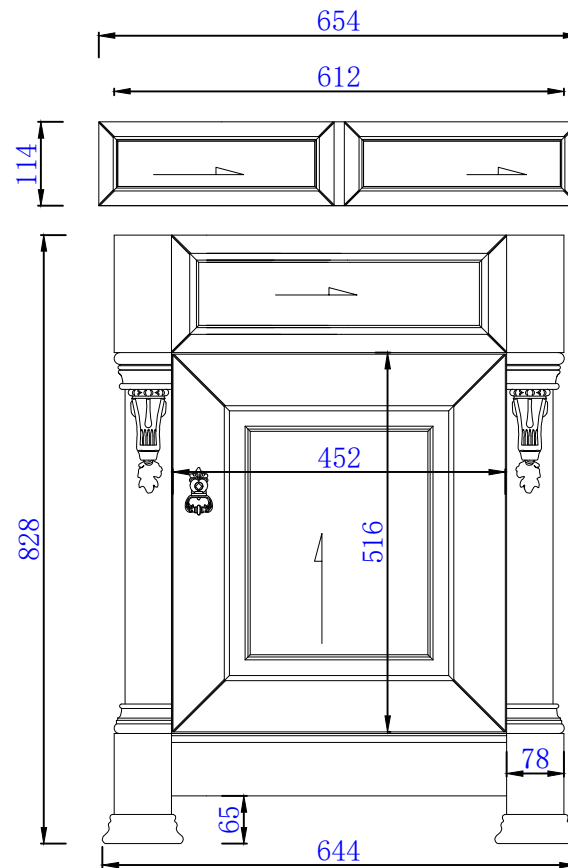

NOTE ONE: Countertops are not shown in these diagrams .(Cabinet Only)

NOTE TWO: Wood Backsplash (Shown) is designed for the molding detail to align with sinks in James Martin's Optional Countertops.

Customers' own countertops and sinks may align differently.

Please consult our website for Countertop Diagrams: www.jamesmartinvanities.com

Version:202107

660mm

Item Number:
147-114-V26-AQB
147-114-V26-BNM
147-114-V26-COK
147-114-V26-WCH
147-114-V26-BW

JAMES MARTIN

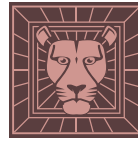

VANITIES™

Brookfield 660mm Single Vanity Cabinet

Diagrams with Dimensions

page 02 of 03

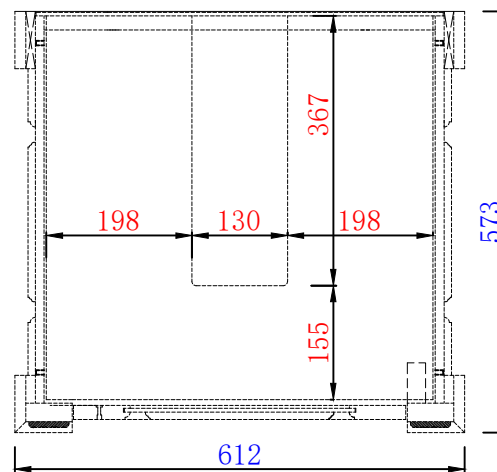
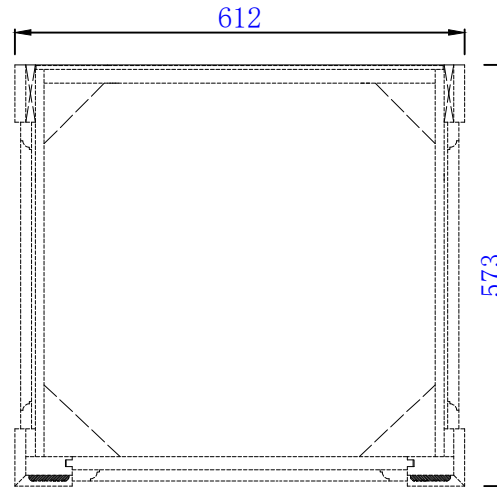

NOTE ONE: Countertops are not shown in these diagrams .(Cabinet Only)

NOTE TWO: Internal Shelves (Shown) are designed to align with sinks in James Martin's Optional Countertops.

Customers' own countertops and sinks may align differently, and modification may be required.

Please consult our website for Countertop Diagrams: www.jamesmartinvanities.com

Version:202107

660mm

Item Number:
147-114-V26-AQB
147-114-V26-BNM
147-114-V26-COK
147-114-V26-WCH
147-114-V26-BW

JAMES MARTIN

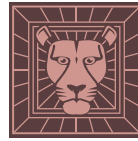

VANITIES™

Brookfield 660mm Single Vanity Cabinet

Diagrams with Dimensions

page 03 of 03

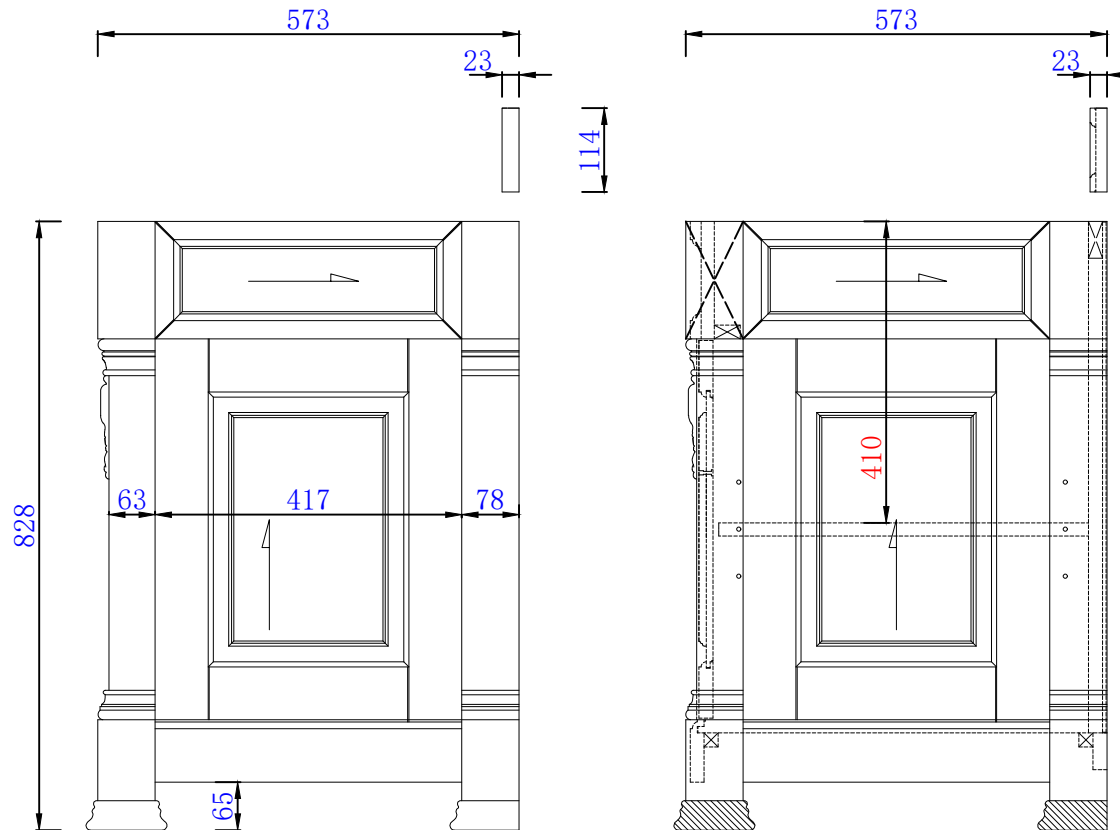

NOTE ONE: Countertops are not shown in these diagrams .(Cabinet Only)

NOTE TWO: Wood Backsplash (Shown) is designed for the molding detail to align with sinks in James Martin's Optional Countertops.

Customers' own countertops and sinks may align differently.

Please consult our website for Countertop Diagrams: www.jamesmartinvanities.com

Version:202107