

Installation manual for:
2092D16C/RC

Dimensions: D16" H9" L10

Collection: Influx

Bulb Type: G9 bulb

Weigh: 13.55 LBS



Thank you for choosing our exquisite chandelier. We are providing the finest quality crystal chandelier for our customers. Our master designers and craftsmen intend to give a professional insight on lighting design and product quality. Prompt and efficient services are our priority. We enclosed detail instructions on how to install your light fixture properly. Please read all instructions carefully and thoroughly. If you have any questions, our professional customer service team is committed to assisting you, please call our toll free HOTLINE AT:

1-888-388-3390



C



US

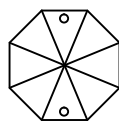

SAFETY

Warning: BE SURE THE ELECTRICITY TO THE WIRES YOU ARE WORKING ON IS SHUT OFF,,EITHER THE FUSE IS REMOVED OR THE CIRCUIT BREAKER IS TURNED OFF.

CAUTION

- Before assembling the lighting fixture, please read all instructions carefully.
- All frame & crystal components are fragile,please handle with care.
- Required supply circuit : 110-130V/60Hz
- Labeled wires are "L" for live wire,"N" for neutral wire, "E" for ground wire.
- Never install fixture on damp ceiling, the room should be dry and well ventilated
- All electrical components must be installed by licensed electrician and in accordance with the National·Electrical Code and the appropriate local electrical codes.







Unpack the package

Please open the box carefully and check all items are inside the box. If you have any installation, assembling and missing parts questions, please call our Customer Service department at 1-888-388-3390. please have model number (at the front page),where you purchase from and any other relevant information ready,our customer service team will provide comprehensive and worry free service to you valued customers.

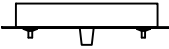
Step 1

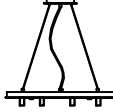
Please use the partslist to ensure you are not missing any parts.

PARTS LIST

PART#	Picture	Description	Qty	Check list
01		mounting bracket(A)	1	
02		canopy	1	
03		screw cap (on canopy 02)	2	
04		socket (on lamp body 05)	10	
05		lamp body	1	
06		Shade	1	
07		screw cap (on canopy 02)	4	
08		mounting bracket(B) (on lamp body 05)	1	
A		crystal	91	

Step 2

Canopy installation instructions

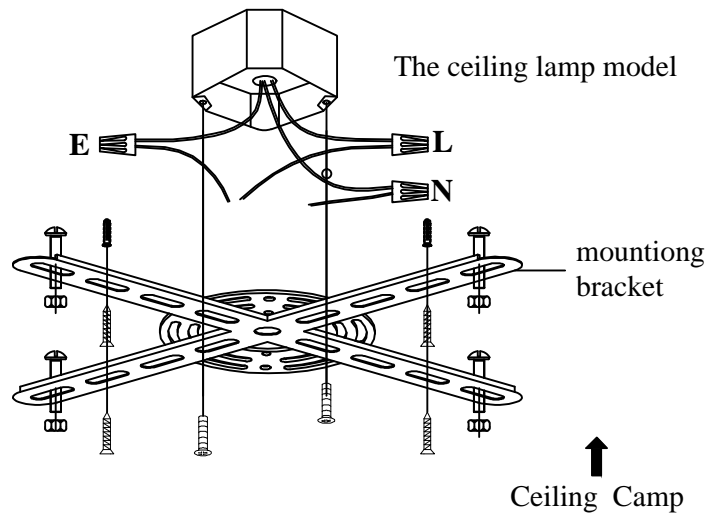
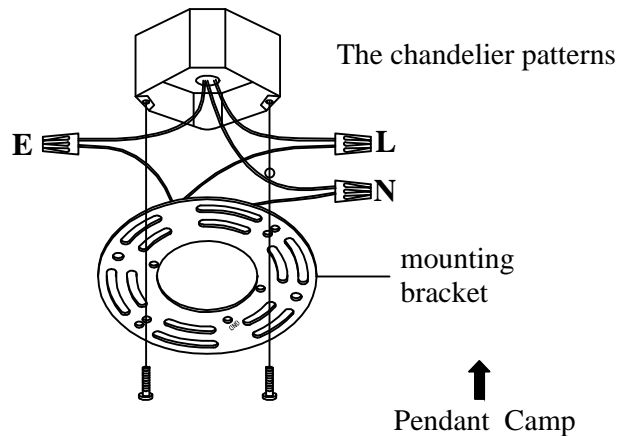

Returns and Conditions of Warranty

Returns must be pre-authorized by contacting our customer service department at the address on the reverse side. Returns will only be accepted with a written return merchandise authorization and return shipping charges pre-paid. We reserve the right to inspect all returned merchandise to fully determine the nature of any defect. This guarantee shall not apply to any product that has been changed, altered or otherwise modified, nor shall it apply to any product that has been repaired or altered by anyone other than a pre-authorized facility. We will not be responsible for any breakage or damages incurred during transit, nor for crystal parts or metal frame part that have been subject to misuse, negligence, accident or inappropriate handling. Also, we will not be held responsible for damage incurred during improper installation or wiring by others, nor for damages resulting from a failure to follow the recommended maintenance or installation procedures. This guarantee is issued in lieu of any and all other guaranteed or warranty, whether written or implied and any and all other obligations or liabilities. Further, we neither authorize nor permit any other person or firm to assume for us, any liability in connection with the sale of our products.

Elegant Lighting Warranty

The finish and frame of your new chandelier or fixture warranted for a period of two (2) years from the date of purchase. Our company will, at its option, repair or replace any frame that has a defect in the materials or workmanship during the warranty period. All crystals are guaranteed for their original quality during the life of the chandelier. Breakage is not covered by this warranty.

To make a claim under this warranty, contact our customer service department at the address and phone number shown below. A written return authorization form will be sent to you with specific instructions

CUSTOMER SERVICE DEPARTMENT

500-550 E. Erie Avenue

Philadelphia, PA 19134

Tel : 215-423-8880

Fax : 215-423-8882

Important: This product must be installed in accordance with the local installation codes by a person familiar with construction and operation of this product and the hazards involved.

1. Black wire from ceiling (junction box) attaches to "L" wire from the fixture
2. White wire from ceiling (junction box) attaches to "N" wire from the fixture.
3. "E" wire from the fixture is attached to the mounting bracket and an additional "E" wire from the mounting bracket must be secured to the junction box.
4. Secure mounting bracket to the junction box.
5. Insert screws in side of top unit into the mounting bracket.

Frame Assembly Diagram

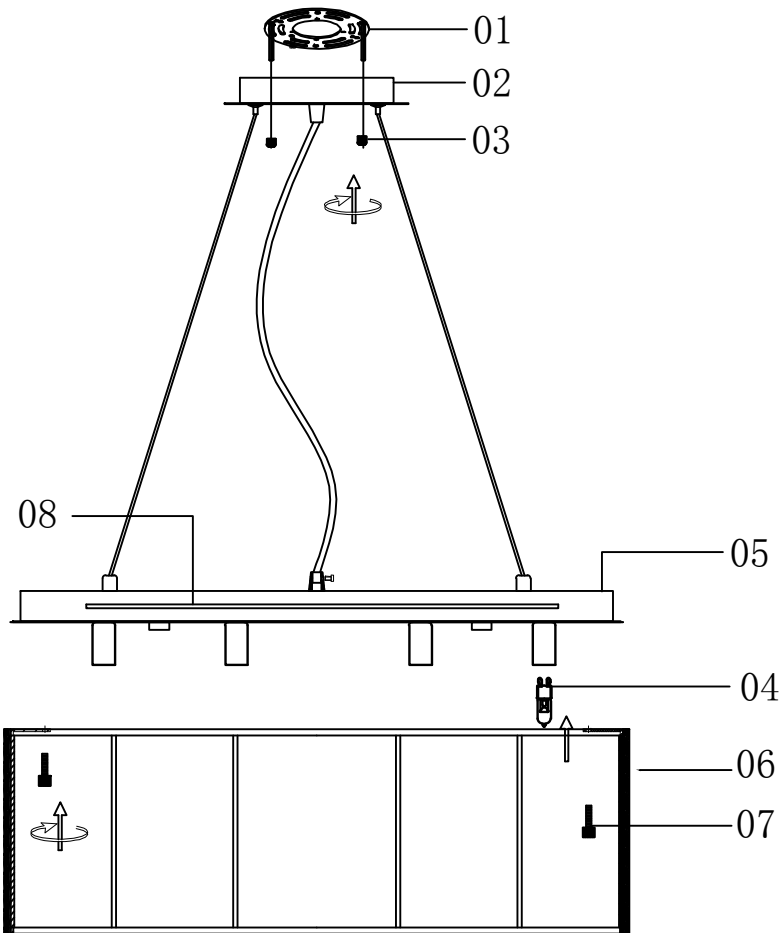

Cleaning and Maintenance of Chandelier Frame

The finish on our chandelier frames and fixture frames is protected by a durable coating of lacquer. To clean, use a clean soft, dry cloth. Do not use any metal polishes, cleaners, abrasives or any substance which could remove the protective finish.

Failure to follow these instructions automatically voids the guarantee .

Cleaning and Maintenance of Crystals

Wet a chamois in clean warm water and wipe gently, then polish with a dry chamois.

To Order Crystal Replacement Parts

Should you require replacement crystals or pins (the metal connectors attaching the crystals), contact the store where the product was purchased or contact us at the address shown on the reverse side. For ease of ordering, you may use the original crystal trimming instructions provided with this product and circle the items you wish to order, indicating the quantity by writing the number needed adjacent to the circle and faxing it to our customer service department at 215-423-8882. You will be contacted with prices prior to shipment. All orders must be pre-paid.

Congratulations!

You are now done installing your Elegant Lighting fixture. Sit back and admire each crystal as it will become the statement piece for your room/house.

If you require any additional assistance, please contact us at 1-888-388-3390.

Thank you.

Step 3

Frame Assembly Instructions

Installation:

Please read all instructions carefully. Before you proceed to install, make sure that the power supply is turned off and remains off until installation is complete.

Please note that each part has been assigned a number and proceed in a numerical order.

1. Loosen the two crossbar screw caps(03) from the canopy (02), remove the crossbar(01) install on the "03" junction box(electrician box from your side), make sure crossbar(01) is mounted securely onto the box.
2. Connect the wire "L" and "N" from the lamp body(05) to junction box and "E" to the crossbar, use screws to fasten.(installation by professional electrician recommended)
3. Affix lamp body(05) to crossbar and lock in place using screw caps(03) provided.
4. Affix lamp shade (06) to the body(05) by screws cap(07)
5. Follow the crystal dressing instruction on following page to dress the crystal.
6. When you want to use the ceiling, the ceiling plate removed and then reverse the lights of the wafer down and tube, and then use 07 as your mounting bracket(B).

Step 4 Crystal Dressing Instructions

1. Crystal "A" has been fixed at lamp body(05), just put the Crystal hanging lamp body.

Crystal Dressing Diagram

When dressing the chandelier with the crystals please remember to wear either rubber or cotton gloves. So as to prevent any damage or smudging on the crystals.

