

LIVING DISTRICT

Collection:

Installation manual for:











LDOD4019 W7.00" H7.00" E2.75" L1

Installation instructions:

1. Black wire from ceiling(junction box) attaches to "L"wire from the fixture.
2. White wire from ceiling(junction box) attaches to "N"wire from the fixture.
3. "E" wire from the fixture is attached to the mounting bracket and an additional "E" wire from the mounting bracket must be secured to the junction box.
4. Secure mounting bracket to the junction box.
5. Insert screws (P2) in the side of the mounting bracket(P1).
6. Align the holes on the side of the base(P3) and secure with the screw (P4)

The end!

PARTS LIST

Part	Picture	Description	Qty	Check list
P1		Mounting bracket	1	
P2		5/32-32 screw	2	
P3		Base	1	
P4		Screw	2	
P5		Fixture	1	
P6		Silicone rubber	1	
P7		LED 3000K	1	
P8		Glass	1	
P9		Iron sheet	1	
P10		Power wire 8' E327219 18AWG BLACK/WHITE	1	

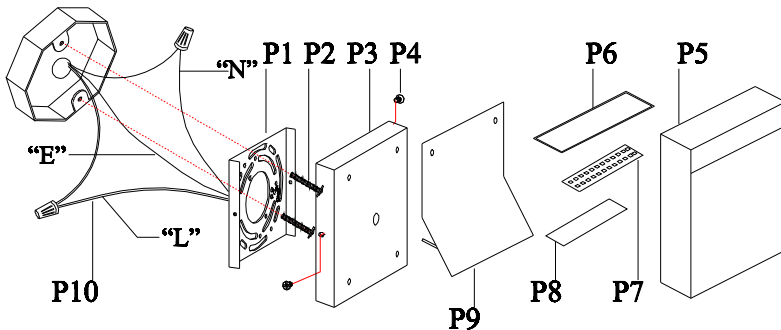

"L" = Hot wire

"N" = Neutral wire

"E" = Ground wire