

Installation manual for



9800F14C/RC, 9800F14G/RC
9800F14C/EC, 9800F14G/EC
9800F14C/SA, 9800F14G/SA
9800F14C/SS, 9800F14G/SS

Dimensions : D14"H7"L4
Collection : Rococo
Bulb Type : E12 bulb not included
Weight : 20 LBS



Thank you for choosing world famous brand chandelier. We are providing the finest quality crystal chandelier for our customers. Our master designers and craftsmen intend to give a professional insight on lighting design & product quality. Prompt and efficient services are our priority. We enclosed detail instructions on how to install your chandelier properly. Please read all instructions carefully & thoroughly. If you have any questions, our professional customer service team committed provided all the information of our products, please call our toll free

CHANDELIER HOTLINE AT:

1-888-388-3390   **US**

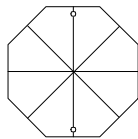

9800F14 D14"H7"L4

SAFETY

Warning: MAKE SURE THE ELECTRICITY TO THE WIRES YOU ARE WORKING ON IS SHUT OFF BY EITHER REMOVING THE FUSE OR TURN OFF THE CIRCUIT BREAKER

CAUTION

- Before assembling the lighting fixture, please read all instructions carefully.
- All frame & crystal components are fragile, please handle with care.
- Required supply circuit : 110 - 130V/60Hz
- Labeled wires are "L" for live wire, "N" for neutral wire, "E" for ground wire.
- Never install fixture on damp ceiling, the room should be dry and well ventilated
- All electrical components must be installed by licensed electrician and in accordance with the National Electrical Code and the appropriate local electrical codes.

Unpack the Package

Please open the box carefully and check all the items are inside the box. If you have any installation, assembling and missing parts questions, please call our Customer Service department at 1-888-388-3390. Please have model number (at the front page), where you purchase from and any other relevant information ready, our customer service team will provide comprehensive and worry free service to our valued customers.

01

9800F14 D14"H7"L4

Step 1

Frame Assembly Diagram

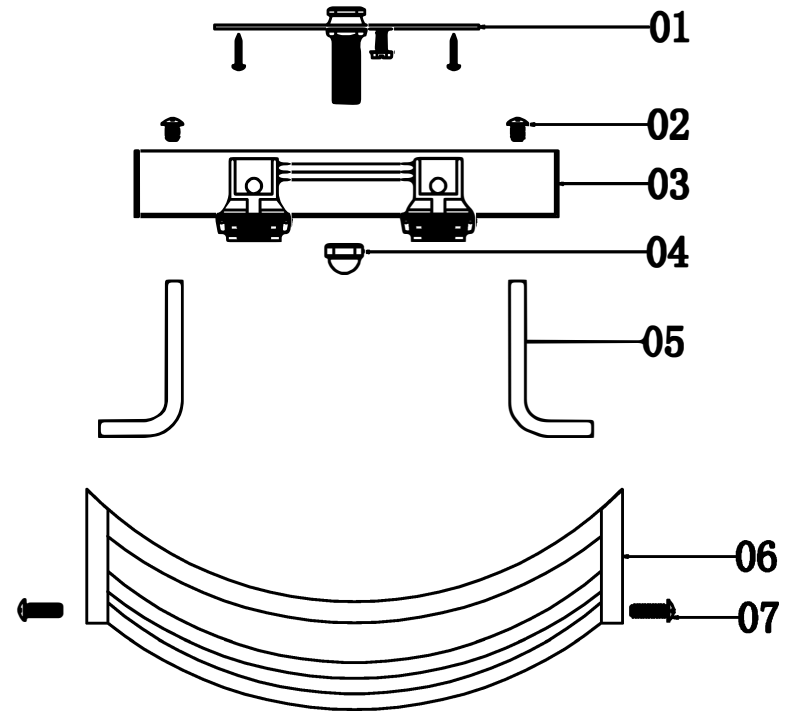









02

9800F14 D14"H7"L4

Please use the partslist to ensure you are not missing any parts.

9800F14 PARTS LIST

Part#	Picture	Description	Qty	Check list
01		Crossbar	1	
02		L6mm Screw	4	
03		Round Plate	1	
04		Screw Cap	1	
05		SQ Metal Pole	4	
06		Lamp Body	1	
07		L18mm Screw	4	
A		701-40#	81	

9800F14 D14"H7"L4

Step 2

Canopy Installation Instruction

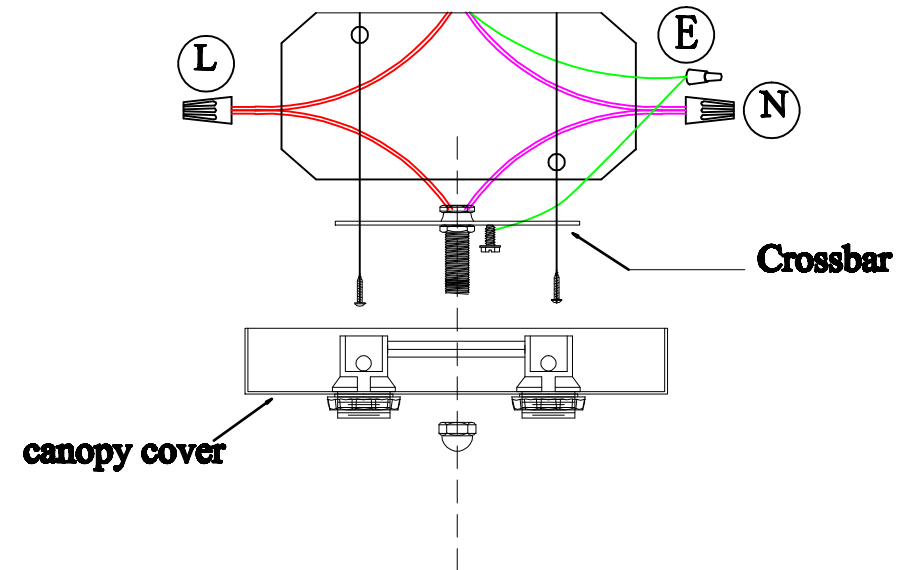

"L" = Hot wite
 "N" = Neutral wite
 "E" = Ground wite

9800F14 D14"H7"L4

IMPORTANT: Test sockets with bulb before dressing the fixture.

1 .Attach the crossbar to the electrical box.

2 .Pull wires up through the nipple.

3 .Attach the fixture to the ceiling.

4 .Make the electrical connections as detailed in the drawing above.

05

9800F14 D14"H7"L4

Step 3

Frame Assembly Diagram

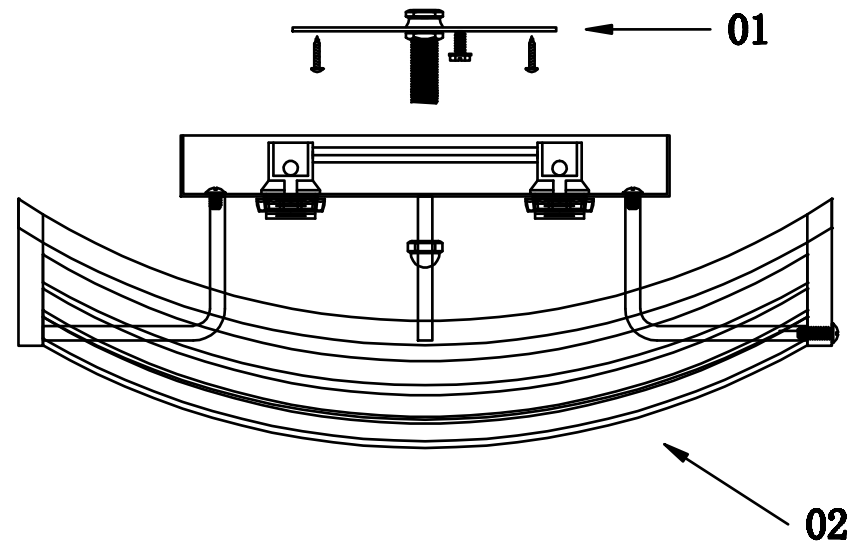

06

9800F14 D14"H7"L4

Frame Assembly Instructions

Installation:

Please read all instructions carefully. Before you proceed to install, make sure that the power supply is turned off and remains off until installation is complete. Please note that each part has been assigned a number. Please proceed in a numerical order.

1. Hang the Crossbar (01) on the ceiling.
2. Hang the lamp body (02) on the Crossbar (01).
3. Follow the crystal instruction to hang the crystal.

The end !

07

9800F14 D14"H7"L4

Step 4

Crystal Dressing Diagram



When dressing the chandelier with the crystals please remember to wear either rubber or cotton gloves. So as to prevent any damage or smudging on the crystals.

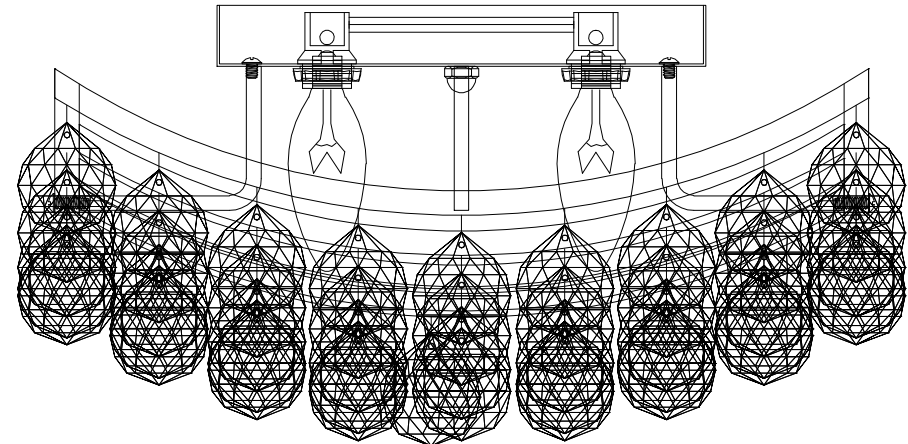

A

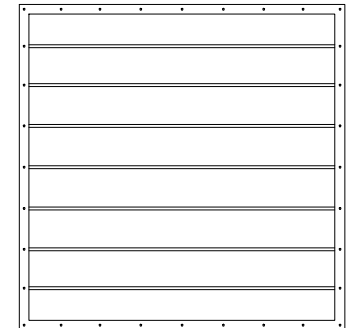

08

9800F10 L10"W10"H8"L4

Congratulations !

You are now done installing your Elegant Lighting fixture. Sit back and admire each crystal as it will become the statement piece for your room/house.

If you require any additional assistance, please contact us at 1-888-388-3390.

Thank you.

9800F10 L10"W10"H8"L4

Cleaning and Maintenance of Chandelier Frame

The finish on our chandelier frames and fixture frames is protected by a durable coating of lacquer. To clean, use a clean soft, dry cloth. Do not use any metal polishes, cleaners, abrasives or any substance which could remove the protective finish. Failure to follow these instructions automatically voids the guarantee.

Cleaning and Maintenance of Crystals

Wet a chamois in clean warm water and wipe gently, then polish with a dry chamois.

To Order Crystal Replacement Parts

Should you require replacement crystals or pins (the metal connectors attaching the crystals), contact the store where the product was purchased or contact us at the address shown on the reverse side. For ease of ordering, you may use the original crystal trimming instructions provided with this product and circle the items you wish to order, indicating the quantity by writing the number needed adjacent to the circle and faxing it to our customer service department at 215-423-8882. You will be contacted with prices prior to shipment. All orders must be pre-paid.

9800F10 L10"W10"H8"L4

Elegant Lighting Warranty

The finish and frame of your new chandelier or fixture warranted for a period of two (2) years from the date of purchase. Our company will, at its option, repair or replace any frame that has a defect in the materials or workmanship during the warranty period. All crystals are guaranteed for their original quality during the life of the chandelier. Breakage is not covered by this warranty.

To make a claim under this warranty, contact our customer service department at the address and phone number shown below. A written return authorization form will be sent to you with specific instructions.

CUSTOMER SERVICE DEPARTMENT

500-550 E. Erie Avenue

Philadelphia, PA 19134

Tel : 215-423-8880

Fax : 215-423-8882

9800F10 L10"W10"H8"L4

Returns and Conditions of Warranty

Returns must be pre-authorized by contacting our customer service department at the address on the reverse side. Returns will only be accepted with a written return merchandise authorization and return shipping charges pre-paid. We reserved the right to inspect all returned merchandise to fully determine the nature of any defect. This guarantee shall not apply to any product that has been changed, altered or otherwise modified, nor shall it apply to any product that has been repaired or altered by anyone other than a pre-authorized facility. We will not be responsible for any breakage or damages incurred during transit, nor for crystal parts or metal frame part that have been subject to misuse, negligence, accident or inappropriate handling. Also, we will not be held responsible for damage incurred during improper installation or wiring by others, nor for damages resulting from a failure to follow the recommended maintenance or installation procedures. This guarantee is issued in lieu of any and all other guaranteed or warranty, whether written or implied and any and all other obligations or liabilities. Further, we neither authorize nor permit any other person or firm to assume for us, any liability in connection with the sale of our products.