

PRODUCT SPECIFICATIONS

Elkay Quartz Luxe® 35-7/8" x 21-9/16" x 9" Single Bowl 10" Apron Farmhouse Workstation Sink with Perfect Drain®. Proprietary manufacturing process that combines natural quartz with high performance UV-stable acrylic resins results in an impact resistant, nonporous and heat-, scratch-, stain- and fade-resistant surface. Naturally sound deadening and Rear Center drain placement.



| | |
|------------------------------|--|
| Installation Type: | Farmhouse, Sink Kits |
| Material: | Quartz |
| Special Features: | Perfect Drain Workstation |
| Finish: | Arctic Fox (FX), Caviar (CA), Charcoal (CH), Chestnut (CN), Jubilee (JB), Obsidian (DN), Parchment (PA), Ricotta (RT), Sandstone (SD), Silvermist (SM) |
| Number of Bowls: | 1 |
| Sink Dimensions: | 35-7/8" x 21-9/16" x 10" |
| Bowl 1 Dimensions: | 32-5/8" x 15-3/4" x 8-1" |
| Drain Size: | 3-5/8" (92mm) |
| Drain Location: | Rear Center |
| Minimum Cabinet Size: | 36" |
| Mounting Hardware: | Part # 54300408 included |
| Template Included: | No |

Included with Product:

- LKCB1812AC cutting board,
- LKPDQ1CR drain,
- LKPDQSRT strainer,
- LKPDQD1RT flange,
- LKDR071787 & LKDR1318RU drying racks,
- LKC0718SS colander,
- LKCLKIT

Special Note: Reserve Selection products are sold exclusively, in-store and online, through authorized wholesalers.

Perfect Drain: Seamlessly molded collar eliminates the gap between a traditional drain and the sink for a more sanitary and gap free installation. Select garbage disposers can be installed on either sink bowl for user convenience. Please see our Garbage Disposer Compatibility Guide.

A Century of Tradition and Quality. For more than 100 years, Elkay has been making innovative products and providing exceptional customer care. We take pride in offering plumbing products that make life easier, inspire change and leave the world a better place.



Product Compliance:
Accessory:

CSA B45.5/IAPMO Z124
ASME A112.18.2/CSA B125.2



Sinks are listed by IAPMO® as meeting the applicable requirements of the Uniform Plumbing Code®, International Plumbing Code®, and National Plumbing Code of Canada.

- [Clean and Care Manual \(PDF\)](#)
- [Installation Instructions \(PDF\) - 1000005326](#)
- [Installation Instructions \(PDF\) - 1000004396](#)
- [Installation Instructions \(PDF\) - 1000003889 perfect-drain](#)
- [Installation Instructions \(PDF\) - Garbage Disposer Compatibility Guide](#)
- [Warranty \(PDF\)](#)

PART: _____ QTY: _____
 PROJECT: _____
 CONTACT: _____
 DATE: _____
 NOTES: _____
 APPROVAL: _____

In keeping with our policy of continuing product improvement, Elkay reserves the right to change product specifications without notice. Please visit elkay.com for the most current version of Elkay product specification sheets. This specification describes an Elkay product with design, quality, and functional benefits to the user. When making a comparison of other producers' offerings, be certain these features are not overlooked.

Installation Profile:

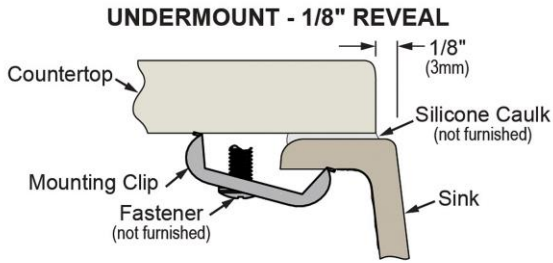



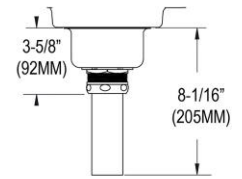
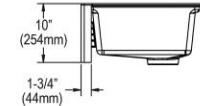
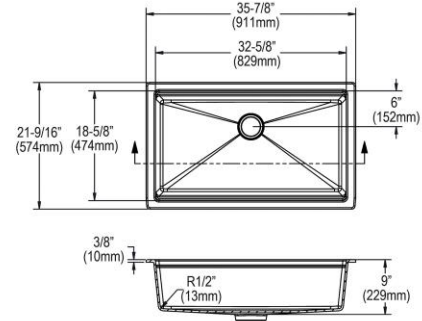

Designed to affix to the underside of any solid surface countertop.

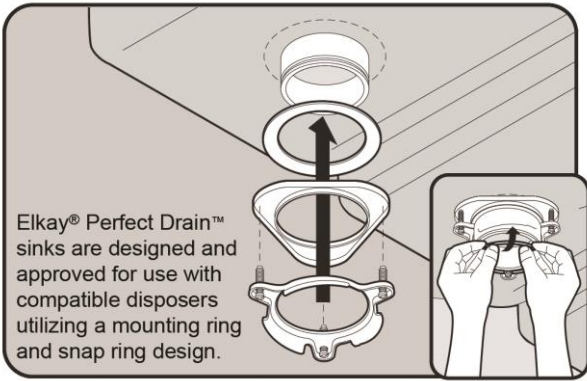





Sink with Drain Kit Installed



| Included Accessories | | |
|----------------------------|--|---|
| LKCB1812HW | Elkay Hardwood 12-1/2" x 18" x 1-1/2" Cutting Board Spec Sheet (PDF) |  |
| LKPDQ1CR | Elkay Perfect Drain Fitting Type 304 Stainless Steel Body and Strainer Chrome Spec Sheet (PDF) |  |
| LKPDQD1 | Elkay Quartz Perfect Drain [®] 3-1/2" Polymer Disposer Flange with Removable Basket Strainer and Rubber Stopper Spec Sheet (PDF) |  |
| LKPDQS | Elkay Quartz Perfect Drain [®] 3-1/2" Removable Polymer Basket Strainer and Rubber Stopper Spec Sheet (PDF) |  |

Optional Accessories

In keeping with our policy of continuing product improvement, Elkay reserves the right to change product specifications without notice. Please visit elkay.com for the most current version of Elkay product specification sheets. This specification describes an Elkay product with design, quality, and functional benefits to the user. When making a comparison of other producers' offerings, be certain these features are not overlooked.

| | | |
|-----------------------------|---|---|
| LKOBG3014SS | <p>Elkay Stainless Steel 14-7/16" x 29-15/16" x 1-1/4" Bottom Grid</p> <p>Spec Sheet (PDF)</p> |  |
| LKPDQ1LS | <p>Elkay Perfect Drain Fitting Type 304 Stainless Steel Body and Strainer Lustrous Steel</p> <p>Spec Sheet (PDF)</p> |  |
| LKPDQS | <p>Elkay Quartz Perfect Drain® 3-1/2" Removable Polymer Basket Strainer and Rubber Stopper</p> <p>Spec Sheet (PDF)</p> |  |
| LKPDQD1 | <p>Elkay Quartz Perfect Drain® 3-1/2" Polymer Disposer Flange with Removable Basket Strainer and Rubber Stopper</p> <p>Spec Sheet (PDF)</p> |  |
| LK6000 | <p>Elkay Everyday Single Hole Deck Mount Kitchen Faucet with Pull-down Spray Forward Only Lever Handle</p> <p>Spec Sheet (PDF)</p> |  |

In keeping with our policy of continuing product improvement, Elkay reserves the right to change product specifications without notice. Please visit elkay.com for the most current version of Elkay product specification sheets. This specification describes an Elkay product with design, quality, and functional benefits to the user. When making a comparison of other producers' offerings, be certain these features are not overlooked.